

|                            |  |     |     |                                  |                     |                       |                         |                                |
|----------------------------|--|-----|-----|----------------------------------|---------------------|-----------------------|-------------------------|--------------------------------|
| SPARE PARTS LIST/予備品リスト    |  | □ - | □ - | APPROVED BY/承認<br>Y. ICHIRAKU    | CHECKED BY/検<br>--- | DESIGNED BY/設計<br>--- | DRAWN BY/描<br>T. YAMADA | DATE DRAWN/描日<br>JAN. 05. 2005 |
| MODEL CODE/型式<br><br>TL-40 |  |     |     | <b>TAISEIKOGYO<br/>CO., LTD.</b> |                     |                       |                         |                                |

| PART NO.<br>部品番号 | PARTICULARS<br>部品名称 | SKETCH<br>概略図 | MATERIAL<br>材質 | QUANTITY<br>(FOR 1 UNIT)<br>数量 (1台分) |             | REMARKS<br>備考<br><br>FOR ELEMENT REPLACEMENT<br>◎: エLEMENT交換用 |
|------------------|---------------------|---------------|----------------|--------------------------------------|-------------|---------------------------------------------------------------|
|                  |                     |               |                | WORKING<br>常備                        | SPARE<br>予備 |                                                               |

|   |                  |  |                     |   |  |             |
|---|------------------|--|---------------------|---|--|-------------|
| 4 | ELEMENT<br>エレメント |  | ANOTHER TABLE<br>別表 | 1 |  | P-TL-40<br> |
|---|------------------|--|---------------------|---|--|-------------|

| SYMBOL<br>記号 | MATERIAL<br>材質           |      |                                          |      |                                     |  |  |
|--------------|--------------------------|------|------------------------------------------|------|-------------------------------------|--|--|
| 8C           | FIBER<br>SECC<br>(β≥200) | 5UW  | SUS304<br>SUS316<br>(WIRE GAUZE)<br>(金網) | 200W | SUS<br>SECC<br>(WIRE GAUZE)<br>(金網) |  |  |
| 25C          |                          | 10UW |                                          | 150W |                                     |  |  |
| 10U          | PAPER/紙<br>SECC          | 20UW | SUS<br>SECC<br>(WIRE GAUZE)<br>(金網)      | 100W |                                     |  |  |
| 20U          |                          | 40UW |                                          | 60W  |                                     |  |  |
| 40U          |                          | 50UW |                                          | 40W  |                                     |  |  |

|   |                 |  |     |   |  |   |
|---|-----------------|--|-----|---|--|---|
| 5 | PACKING<br>パッキン |  | NBR | 2 |  | ◎ |
|---|-----------------|--|-----|---|--|---|

|   |                 |  |     |   |  |   |
|---|-----------------|--|-----|---|--|---|
| 7 | PACKING<br>パッキン |  | NBR | 1 |  | ◎ |
|---|-----------------|--|-----|---|--|---|

|    |                      |  |     |   |  |                             |
|----|----------------------|--|-----|---|--|-----------------------------|
| 10 | O O R I N G<br>O リング |  | NBR | 1 |  | JIS B2401, 1A<br>G-115<br>◎ |
|----|----------------------|--|-----|---|--|-----------------------------|

|    |                 |  |                         |   |  |                      |
|----|-----------------|--|-------------------------|---|--|----------------------|
| 11 | PACKING<br>パッキン |  | NON ASBESTOS<br>ノンアスベスト | 1 |  | JIS10K-175A, FF<br>◎ |
|----|-----------------|--|-------------------------|---|--|----------------------|

|                            |  |     |     |                                  |                     |                      |                         |                               |
|----------------------------|--|-----|-----|----------------------------------|---------------------|----------------------|-------------------------|-------------------------------|
| SPARE PARTS LIST/予備品リスト    |  | □ - | □ - | APPROVED BY/審<br>Y. ICHIRAKU     | CHECKED BY/備<br>--- | DESIGNED BY/設<br>--- | DRAWN BY/描<br>T. YAMADA | DATE DRAWN/日<br>JAN. 05. 2005 |
| MODEL CODE/型式<br><br>TL-50 |  |     |     | <b>TAISEIKOGYO<br/>CO., LTD.</b> |                     |                      |                         |                               |

| PART NO.<br>部品番号 | PARTICULARS<br>部品名称 | SKETCH<br>概略図 | MATERIAL<br>材質 | QUANTITY<br>(FOR 1 UNIT)<br>数量 (1台分) |             | REMARKS<br>備考<br><br>FOR ELEMENT REPLACEMENT<br>◎: エLEMENT交換用 |
|------------------|---------------------|---------------|----------------|--------------------------------------|-------------|---------------------------------------------------------------|
|                  |                     |               |                | WORKING<br>常備                        | SPARE<br>予備 |                                                               |

|   |                  |  |                     |   |  |                  |
|---|------------------|--|---------------------|---|--|------------------|
| 4 | ELEMENT<br>エレメント |  | ANOTHER TABLE<br>別表 | 1 |  | P-TL-50<br><br>◎ |
|---|------------------|--|---------------------|---|--|------------------|



| SYMBOL<br>記号 | MATERIAL<br>材質           |      |                                          |      |                                     |      |  |
|--------------|--------------------------|------|------------------------------------------|------|-------------------------------------|------|--|
| 8C           | FIBER<br>SECC<br>(β≥200) | 5UW  | SUS304<br>SUS316<br>(WIRE GAUZE)<br>(金網) | 200W | SUS<br>SECC<br>(WIRE GAUZE)<br>(金網) | 150W |  |
| 25C          |                          | 10UW |                                          | 100W |                                     |      |  |
| 10U          | PAPER/紙<br>SECC          | 20UW | SUS<br>SECC<br>(WIRE GAUZE)<br>(金網)      | 100W |                                     | 60W  |  |
| 20U          |                          | 40UW |                                          | 40W  |                                     |      |  |
| 40U          |                          | 50UW |                                          | 40W  |                                     |      |  |

|   |                 |  |     |   |  |   |
|---|-----------------|--|-----|---|--|---|
| 5 | PACKING<br>パッキン |  | NBR | 2 |  | ◎ |
|---|-----------------|--|-----|---|--|---|

|   |                 |  |     |   |  |   |
|---|-----------------|--|-----|---|--|---|
| 7 | PACKING<br>パッキン |  | NBR | 1 |  | ◎ |
|---|-----------------|--|-----|---|--|---|

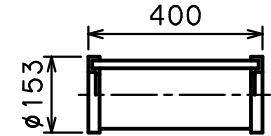

|    |                      |  |     |   |  |                             |
|----|----------------------|--|-----|---|--|-----------------------------|
| 10 | O O R I N G<br>O リング |  | NBR | 1 |  | JIS B2401, 1A<br>G-140<br>◎ |
|----|----------------------|--|-----|---|--|-----------------------------|

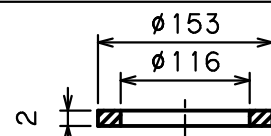
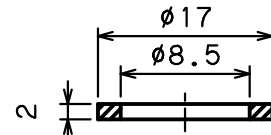
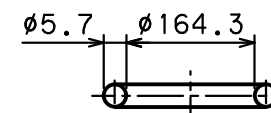
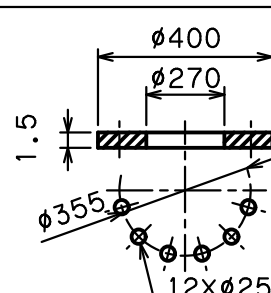
|    |                 |  |                         |   |  |                      |
|----|-----------------|--|-------------------------|---|--|----------------------|
| 11 | PACKING<br>パッキン |  | NON ASBESTOS<br>ノンアスベスト | 1 |  | JIS10K-200A, FF<br>◎ |
|----|-----------------|--|-------------------------|---|--|----------------------|

| SPARE PARTS LIST/予備品リスト |                                                                                                                                                                                                                                                                                                                                                                                                                                                                                                                                                                                                                                                                                                                                                                                                                                                                                                                            | APPROVED BY/承認<br>Y. ICHIRAKU                                                       |                         | CHECKED BY/検<br>---                                                                                              |             | DESIGNED BY/設計<br>---                                                                          |                                  | DRAWN BY/描<br>T. YAMADA |              | DATE DRAWN/描日<br>JAN. 05. 2005 |  |  |  |  |  |  |    |            |  |     |        |  |      |                                  |     |                      |  |      |        |  |      |     |  |  |      |                      |  |      |     |                 |  |      |          |  |     |     |  |  |      |                      |  |     |  |  |  |  |  |  |
|-------------------------|----------------------------------------------------------------------------------------------------------------------------------------------------------------------------------------------------------------------------------------------------------------------------------------------------------------------------------------------------------------------------------------------------------------------------------------------------------------------------------------------------------------------------------------------------------------------------------------------------------------------------------------------------------------------------------------------------------------------------------------------------------------------------------------------------------------------------------------------------------------------------------------------------------------------------|-------------------------------------------------------------------------------------|-------------------------|------------------------------------------------------------------------------------------------------------------|-------------|------------------------------------------------------------------------------------------------|----------------------------------|-------------------------|--------------|--------------------------------|--|--|--|--|--|--|----|------------|--|-----|--------|--|------|----------------------------------|-----|----------------------|--|------|--------|--|------|-----|--|--|------|----------------------|--|------|-----|-----------------|--|------|----------|--|-----|-----|--|--|------|----------------------|--|-----|--|--|--|--|--|--|
| MODEL CODE/型式<br>TL-80  |                                                                                                                                                                                                                                                                                                                                                                                                                                                                                                                                                                                                                                                                                                                                                                                                                                                                                                                            | □ -<br>□ -                                                                          |                         |  <b>TAISEIKOGYO CO., LTD.</b> |             |                                                                                                |                                  |                         |              |                                |  |  |  |  |  |  |    |            |  |     |        |  |      |                                  |     |                      |  |      |        |  |      |     |  |  |      |                      |  |      |     |                 |  |      |          |  |     |     |  |  |      |                      |  |     |  |  |  |  |  |  |
| PART NO.<br>部品番号        | PARTICULARS<br>部品名称                                                                                                                                                                                                                                                                                                                                                                                                                                                                                                                                                                                                                                                                                                                                                                                                                                                                                                        | SKETCH<br>概略図                                                                       | MATERIAL<br>材質          | QUANTITY<br>(FOR 1 UNIT)<br>数量 (1台分)                                                                             |             | REMARKS<br>備考                                                                                  |                                  |                         |              |                                |  |  |  |  |  |  |    |            |  |     |        |  |      |                                  |     |                      |  |      |        |  |      |     |  |  |      |                      |  |      |     |                 |  |      |          |  |     |     |  |  |      |                      |  |     |  |  |  |  |  |  |
|                         |                                                                                                                                                                                                                                                                                                                                                                                                                                                                                                                                                                                                                                                                                                                                                                                                                                                                                                                            |                                                                                     |                         | WORKING<br>常備                                                                                                    | SPARE<br>予備 | FOR ELEMENT REPLACEMENT<br>◎: エLEMENT交換用                                                       |                                  |                         |              |                                |  |  |  |  |  |  |    |            |  |     |        |  |      |                                  |     |                      |  |      |        |  |      |     |  |  |      |                      |  |      |     |                 |  |      |          |  |     |     |  |  |      |                      |  |     |  |  |  |  |  |  |
| 4                       | ELEMENT<br>エレメント                                                                                                                                                                                                                                                                                                                                                                                                                                                                                                                                                                                                                                                                                                                                                                                                                                                                                                           |    | ANOTHER TABLE<br>別表     | 1                                                                                                                |             | P-TL-80<br> |                                  |                         |              |                                |  |  |  |  |  |  |    |            |  |     |        |  |      |                                  |     |                      |  |      |        |  |      |     |  |  |      |                      |  |      |     |                 |  |      |          |  |     |     |  |  |      |                      |  |     |  |  |  |  |  |  |
|                         | <table border="1"> <thead> <tr> <th>SYMBOL<br/>記号</th> <th>MATERIAL<br/>材質</th> <th></th> <th></th> <th></th> <th></th> <th></th> <th></th> </tr> </thead> <tbody> <tr> <td>8C</td> <td>FIBER SECC</td> <td></td> <td>5UW</td> <td>SUS304</td> <td></td> <td>200W</td> <td rowspan="6">SUS SECC<br/>(WIRE GAUZE)<br/>(金網)</td> </tr> <tr> <td>25C</td> <td>(<math>\beta \geq 200</math>)</td> <td></td> <td>10UW</td> <td>SUS316</td> <td></td> <td>150W</td> </tr> <tr> <td>10U</td> <td></td> <td></td> <td>20UW</td> <td>(WIRE GAUZE)<br/>(金網)</td> <td></td> <td>100W</td> </tr> <tr> <td>20U</td> <td>PAPER/紙<br/>SECC</td> <td></td> <td>40UW</td> <td>SUS SECC</td> <td></td> <td>60W</td> </tr> <tr> <td>40U</td> <td></td> <td></td> <td>50UW</td> <td>(WIRE GAUZE)<br/>(金網)</td> <td></td> <td>40W</td> </tr> <tr> <td></td> <td></td> <td></td> <td></td> <td></td> <td></td> <td></td> </tr> </tbody> </table> |                                                                                     |                         |                                                                                                                  |             |                                                                                                |                                  |                         | SYMBOL<br>記号 | MATERIAL<br>材質                 |  |  |  |  |  |  | 8C | FIBER SECC |  | 5UW | SUS304 |  | 200W | SUS SECC<br>(WIRE GAUZE)<br>(金網) | 25C | ( $\beta \geq 200$ ) |  | 10UW | SUS316 |  | 150W | 10U |  |  | 20UW | (WIRE GAUZE)<br>(金網) |  | 100W | 20U | PAPER/紙<br>SECC |  | 40UW | SUS SECC |  | 60W | 40U |  |  | 50UW | (WIRE GAUZE)<br>(金網) |  | 40W |  |  |  |  |  |  |
| SYMBOL<br>記号            | MATERIAL<br>材質                                                                                                                                                                                                                                                                                                                                                                                                                                                                                                                                                                                                                                                                                                                                                                                                                                                                                                             |                                                                                     |                         |                                                                                                                  |             |                                                                                                |                                  |                         |              |                                |  |  |  |  |  |  |    |            |  |     |        |  |      |                                  |     |                      |  |      |        |  |      |     |  |  |      |                      |  |      |     |                 |  |      |          |  |     |     |  |  |      |                      |  |     |  |  |  |  |  |  |
| 8C                      | FIBER SECC                                                                                                                                                                                                                                                                                                                                                                                                                                                                                                                                                                                                                                                                                                                                                                                                                                                                                                                 |                                                                                     | 5UW                     | SUS304                                                                                                           |             | 200W                                                                                           | SUS SECC<br>(WIRE GAUZE)<br>(金網) |                         |              |                                |  |  |  |  |  |  |    |            |  |     |        |  |      |                                  |     |                      |  |      |        |  |      |     |  |  |      |                      |  |      |     |                 |  |      |          |  |     |     |  |  |      |                      |  |     |  |  |  |  |  |  |
| 25C                     | ( $\beta \geq 200$ )                                                                                                                                                                                                                                                                                                                                                                                                                                                                                                                                                                                                                                                                                                                                                                                                                                                                                                       |                                                                                     | 10UW                    | SUS316                                                                                                           |             | 150W                                                                                           |                                  |                         |              |                                |  |  |  |  |  |  |    |            |  |     |        |  |      |                                  |     |                      |  |      |        |  |      |     |  |  |      |                      |  |      |     |                 |  |      |          |  |     |     |  |  |      |                      |  |     |  |  |  |  |  |  |
| 10U                     |                                                                                                                                                                                                                                                                                                                                                                                                                                                                                                                                                                                                                                                                                                                                                                                                                                                                                                                            |                                                                                     | 20UW                    | (WIRE GAUZE)<br>(金網)                                                                                             |             | 100W                                                                                           |                                  |                         |              |                                |  |  |  |  |  |  |    |            |  |     |        |  |      |                                  |     |                      |  |      |        |  |      |     |  |  |      |                      |  |      |     |                 |  |      |          |  |     |     |  |  |      |                      |  |     |  |  |  |  |  |  |
| 20U                     | PAPER/紙<br>SECC                                                                                                                                                                                                                                                                                                                                                                                                                                                                                                                                                                                                                                                                                                                                                                                                                                                                                                            |                                                                                     | 40UW                    | SUS SECC                                                                                                         |             | 60W                                                                                            |                                  |                         |              |                                |  |  |  |  |  |  |    |            |  |     |        |  |      |                                  |     |                      |  |      |        |  |      |     |  |  |      |                      |  |      |     |                 |  |      |          |  |     |     |  |  |      |                      |  |     |  |  |  |  |  |  |
| 40U                     |                                                                                                                                                                                                                                                                                                                                                                                                                                                                                                                                                                                                                                                                                                                                                                                                                                                                                                                            |                                                                                     | 50UW                    | (WIRE GAUZE)<br>(金網)                                                                                             |             | 40W                                                                                            |                                  |                         |              |                                |  |  |  |  |  |  |    |            |  |     |        |  |      |                                  |     |                      |  |      |        |  |      |     |  |  |      |                      |  |      |     |                 |  |      |          |  |     |     |  |  |      |                      |  |     |  |  |  |  |  |  |
|                         |                                                                                                                                                                                                                                                                                                                                                                                                                                                                                                                                                                                                                                                                                                                                                                                                                                                                                                                            |                                                                                     |                         |                                                                                                                  |             |                                                                                                |                                  |                         |              |                                |  |  |  |  |  |  |    |            |  |     |        |  |      |                                  |     |                      |  |      |        |  |      |     |  |  |      |                      |  |      |     |                 |  |      |          |  |     |     |  |  |      |                      |  |     |  |  |  |  |  |  |
| 5                       | PACKING<br>パッキン                                                                                                                                                                                                                                                                                                                                                                                                                                                                                                                                                                                                                                                                                                                                                                                                                                                                                                            |    | NBR                     | 2                                                                                                                |             | ◎                                                                                              |                                  |                         |              |                                |  |  |  |  |  |  |    |            |  |     |        |  |      |                                  |     |                      |  |      |        |  |      |     |  |  |      |                      |  |      |     |                 |  |      |          |  |     |     |  |  |      |                      |  |     |  |  |  |  |  |  |
| 7                       | PACKING<br>パッキン                                                                                                                                                                                                                                                                                                                                                                                                                                                                                                                                                                                                                                                                                                                                                                                                                                                                                                            |   | NBR                     | 4                                                                                                                |             | ◎                                                                                              |                                  |                         |              |                                |  |  |  |  |  |  |    |            |  |     |        |  |      |                                  |     |                      |  |      |        |  |      |     |  |  |      |                      |  |      |     |                 |  |      |          |  |     |     |  |  |      |                      |  |     |  |  |  |  |  |  |
| 10                      | O-RING<br>Oリング                                                                                                                                                                                                                                                                                                                                                                                                                                                                                                                                                                                                                                                                                                                                                                                                                                                                                                             |  | NBR                     | 1                                                                                                                |             | JIS B2401, 1A<br>G-165<br>◎                                                                    |                                  |                         |              |                                |  |  |  |  |  |  |    |            |  |     |        |  |      |                                  |     |                      |  |      |        |  |      |     |  |  |      |                      |  |      |     |                 |  |      |          |  |     |     |  |  |      |                      |  |     |  |  |  |  |  |  |
| 11                      | PACKING<br>パッキン                                                                                                                                                                                                                                                                                                                                                                                                                                                                                                                                                                                                                                                                                                                                                                                                                                                                                                            |  | NON ASBESTOS<br>ノンアスベスト | 1                                                                                                                |             | JIS10K-250A, FF<br>◎                                                                           |                                  |                         |              |                                |  |  |  |  |  |  |    |            |  |     |        |  |      |                                  |     |                      |  |      |        |  |      |     |  |  |      |                      |  |      |     |                 |  |      |          |  |     |     |  |  |      |                      |  |     |  |  |  |  |  |  |

|                             |  |     |     |                                                                                                                      |                     |                      |                         |                               |
|-----------------------------|--|-----|-----|----------------------------------------------------------------------------------------------------------------------|---------------------|----------------------|-------------------------|-------------------------------|
| SPARE PARTS LIST/予備品リスト     |  | □ - | □ - | APPROVED BY/審<br>Y. ICHIRAKU                                                                                         | CHECKED BY/備<br>--- | DESIGNED BY/設<br>--- | DRAWN BY/描<br>T. YAMADA | DATE DRAWN/日<br>JAN. 05. 2005 |
| MODEL CODE/型式<br><br>TL-100 |  |     |     |  <b>TAISEIKOGYO<br/>CO., LTD.</b> |                     |                      |                         |                               |

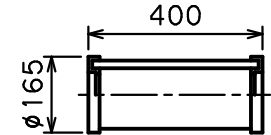
| PART NO.<br>部品番号 | PARTICULARS<br>部品名称 | SKETCH<br>概略図 | MATERIAL<br>材質 | QUANTITY<br>(FOR 1 UNIT)<br>数量 (1台分) |             | REMARKS<br>備考<br><br>FOR ELEMENT REPLACEMENT<br>◎: エLEMENT交換用 |
|------------------|---------------------|---------------|----------------|--------------------------------------|-------------|---------------------------------------------------------------|
|                  |                     |               |                | WORKING<br>常備                        | SPARE<br>予備 |                                                               |

|   |                  |                                                                                   |                     |   |  |                                                                                                 |
|---|------------------|-----------------------------------------------------------------------------------|---------------------|---|--|-------------------------------------------------------------------------------------------------|
| 4 | ELEMENT<br>エレメント |  | ANOTHER TABLE<br>別表 | 1 |  | P-TL-100<br> |
|---|------------------|-----------------------------------------------------------------------------------|---------------------|---|--|-------------------------------------------------------------------------------------------------|

| SYMBOL<br>記号 | MATERIAL<br>材質       |  |      |                   |  |      |                            |
|--------------|----------------------|--|------|-------------------|--|------|----------------------------|
| 8C           | FIBER SECC           |  | 5UW  | SUS304            |  | 200W | SUS SECC (WIRE GAUZE) (金網) |
| 25C          | ( $\beta \geq 200$ ) |  | 10UW | SUS316 (金網)       |  | 150W |                            |
| 10U          |                      |  | 20UW |                   |  | 100W |                            |
| 20U          | PAPER/紙 SECC         |  | 40UW | SUS SECC (金網)     |  | 60W  |                            |
| 40U          |                      |  | 50UW | (WIRE GAUZE) (金網) |  | 40W  |                            |
|              |                      |  |      |                   |  |      |                            |

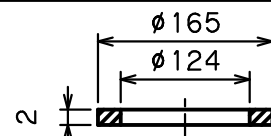
|   |                 |                                                                                   |     |   |  |   |
|---|-----------------|-----------------------------------------------------------------------------------|-----|---|--|---|
| 5 | PACKING<br>パッキン |  | NBR | 2 |  | ◎ |
|---|-----------------|-----------------------------------------------------------------------------------|-----|---|--|---|

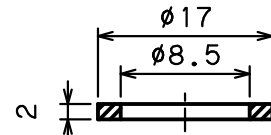
|   |                 |                                                                                    |     |   |  |   |
|---|-----------------|------------------------------------------------------------------------------------|-----|---|--|---|
| 7 | PACKING<br>パッキン |  | NBR | 4 |  | ◎ |
|---|-----------------|------------------------------------------------------------------------------------|-----|---|--|---|

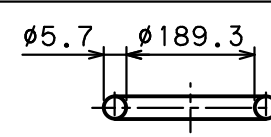
|    |                      |                                                                                     |     |   |  |                             |
|----|----------------------|-------------------------------------------------------------------------------------|-----|---|--|-----------------------------|
| 10 | O O R I N G<br>O リング |  | NBR | 1 |  | JIS B2401, 1A<br>G-190<br>◎ |
|----|----------------------|-------------------------------------------------------------------------------------|-----|---|--|-----------------------------|

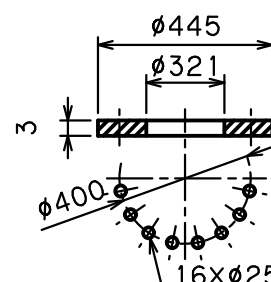
|    |                 |                                                                                     |                         |   |  |                      |
|----|-----------------|-------------------------------------------------------------------------------------|-------------------------|---|--|----------------------|
| 11 | PACKING<br>パッキン |  | NON ASBESTOS<br>ノンアスベスト | 1 |  | JIS10K-300A, FF<br>◎ |
|----|-----------------|-------------------------------------------------------------------------------------|-------------------------|---|--|----------------------|

|                             |  |     |     |                                  |                     |                      |                         |                               |
|-----------------------------|--|-----|-----|----------------------------------|---------------------|----------------------|-------------------------|-------------------------------|
| SPARE PARTS LIST/予備品リスト     |  | □ - | □ - | APPROVED BY/審<br>Y. ICHIRAKU     | CHECKED BY/検<br>--- | DESIGNED BY/設<br>--- | DRAWN BY/描<br>T. YAMADA | DATE DRAWN/日<br>JAN. 05. 2005 |
| MODEL CODE/型式<br><br>TL-150 |  |     |     | <b>TAISEIKOGYO<br/>CO., LTD.</b> |                     |                      |                         |                               |

| PART NO.<br>部品番号 | PARTICULARS<br>部品名称 | SKETCH<br>概略図 | MATERIAL<br>材質 | QUANTITY<br>(FOR 1 UNIT)<br>数量 (1台分) |             | REMARKS<br>備考<br><br>FOR ELEMENT REPLACEMENT<br>◎: エLEMENT交換用 |
|------------------|---------------------|---------------|----------------|--------------------------------------|-------------|---------------------------------------------------------------|
|                  |                     |               |                | WORKING<br>常備                        | SPARE<br>予備 |                                                               |

| 4            | ELEMENT<br>エレメント                                                                                                                                                                                                                                                                                                                                                                                                                                                                                                                                                                                                                                                                                                                                                                                                                                                                                                                                                                                                                                                                                                                                                                                                                                                                                                                                                                                                                                                                                                              |      | ANOTHER TABLE<br>別表                      | 1    |                                     | P-TL-150<br> |              |                |  |  |  |  |  |    |                          |     |                                          |      |                                     |  |     |      |      |  |     |                 |      |                                     |      |  |     |      |     |  |     |      |     |
|--------------|-------------------------------------------------------------------------------------------------------------------------------------------------------------------------------------------------------------------------------------------------------------------------------------------------------------------------------------------------------------------------------------------------------------------------------------------------------------------------------------------------------------------------------------------------------------------------------------------------------------------------------------------------------------------------------------------------------------------------------------------------------------------------------------------------------------------------------------------------------------------------------------------------------------------------------------------------------------------------------------------------------------------------------------------------------------------------------------------------------------------------------------------------------------------------------------------------------------------------------------------------------------------------------------------------------------------------------------------------------------------------------------------------------------------------------------------------------------------------------------------------------------------------------|------|------------------------------------------|------|-------------------------------------|--------------|--------------|----------------|--|--|--|--|--|----|--------------------------|-----|------------------------------------------|------|-------------------------------------|--|-----|------|------|--|-----|-----------------|------|-------------------------------------|------|--|-----|------|-----|--|-----|------|-----|
|              | <table border="1" style="margin: auto;"> <thead> <tr> <th style="width: 10%;">SYMBOL<br/>記号</th> <th style="width: 15%;">MATERIAL<br/>材質</th> <th style="width: 10%;"></th> <th style="width: 10%;"></th> <th style="width: 10%;"></th> <th style="width: 10%;"></th> <th style="width: 10%;"></th> </tr> </thead> <tbody> <tr> <td style="text-align: center;">8C</td> <td rowspan="2" style="text-align: center;">FIBER<br/>SECC<br/>(β≥200)</td> <td style="text-align: center;">5UW</td> <td rowspan="2" style="text-align: center;">SUS304<br/>SUS316<br/>(WIRE GAUZE)<br/>(金網)</td> <td style="text-align: center;">200W</td> <td rowspan="6" style="text-align: center;">SUS<br/>SECC<br/>(WIRE GAUZE)<br/>(金網)</td> <td></td> </tr> <tr> <td style="text-align: center;">25C</td> <td style="text-align: center;">10UW</td> <td style="text-align: center;">150W</td> <td></td> </tr> <tr> <td style="text-align: center;">10U</td> <td rowspan="4" style="text-align: center;">PAPER/紙<br/>SECC</td> <td style="text-align: center;">20UW</td> <td rowspan="4" style="text-align: center;">SUS<br/>SECC<br/>(WIRE GAUZE)<br/>(金網)</td> <td style="text-align: center;">100W</td> <td></td> </tr> <tr> <td style="text-align: center;">20U</td> <td style="text-align: center;">40UW</td> <td style="text-align: center;">60W</td> <td></td> </tr> <tr> <td style="text-align: center;">40U</td> <td style="text-align: center;">50UW</td> <td style="text-align: center;">40W</td> <td></td> </tr> </tbody> </table> |      |                                          |      |                                     |              | SYMBOL<br>記号 | MATERIAL<br>材質 |  |  |  |  |  | 8C | FIBER<br>SECC<br>(β≥200) | 5UW | SUS304<br>SUS316<br>(WIRE GAUZE)<br>(金網) | 200W | SUS<br>SECC<br>(WIRE GAUZE)<br>(金網) |  | 25C | 10UW | 150W |  | 10U | PAPER/紙<br>SECC | 20UW | SUS<br>SECC<br>(WIRE GAUZE)<br>(金網) | 100W |  | 20U | 40UW | 60W |  | 40U | 50UW | 40W |
| SYMBOL<br>記号 | MATERIAL<br>材質                                                                                                                                                                                                                                                                                                                                                                                                                                                                                                                                                                                                                                                                                                                                                                                                                                                                                                                                                                                                                                                                                                                                                                                                                                                                                                                                                                                                                                                                                                                |      |                                          |      |                                     |              |              |                |  |  |  |  |  |    |                          |     |                                          |      |                                     |  |     |      |      |  |     |                 |      |                                     |      |  |     |      |     |  |     |      |     |
| 8C           | FIBER<br>SECC<br>(β≥200)                                                                                                                                                                                                                                                                                                                                                                                                                                                                                                                                                                                                                                                                                                                                                                                                                                                                                                                                                                                                                                                                                                                                                                                                                                                                                                                                                                                                                                                                                                      | 5UW  | SUS304<br>SUS316<br>(WIRE GAUZE)<br>(金網) | 200W | SUS<br>SECC<br>(WIRE GAUZE)<br>(金網) |              |              |                |  |  |  |  |  |    |                          |     |                                          |      |                                     |  |     |      |      |  |     |                 |      |                                     |      |  |     |      |     |  |     |      |     |
| 25C          |                                                                                                                                                                                                                                                                                                                                                                                                                                                                                                                                                                                                                                                                                                                                                                                                                                                                                                                                                                                                                                                                                                                                                                                                                                                                                                                                                                                                                                                                                                                               | 10UW |                                          | 150W |                                     |              |              |                |  |  |  |  |  |    |                          |     |                                          |      |                                     |  |     |      |      |  |     |                 |      |                                     |      |  |     |      |     |  |     |      |     |
| 10U          | PAPER/紙<br>SECC                                                                                                                                                                                                                                                                                                                                                                                                                                                                                                                                                                                                                                                                                                                                                                                                                                                                                                                                                                                                                                                                                                                                                                                                                                                                                                                                                                                                                                                                                                               | 20UW | SUS<br>SECC<br>(WIRE GAUZE)<br>(金網)      | 100W |                                     |              |              |                |  |  |  |  |  |    |                          |     |                                          |      |                                     |  |     |      |      |  |     |                 |      |                                     |      |  |     |      |     |  |     |      |     |
| 20U          |                                                                                                                                                                                                                                                                                                                                                                                                                                                                                                                                                                                                                                                                                                                                                                                                                                                                                                                                                                                                                                                                                                                                                                                                                                                                                                                                                                                                                                                                                                                               | 40UW |                                          | 60W  |                                     |              |              |                |  |  |  |  |  |    |                          |     |                                          |      |                                     |  |     |      |      |  |     |                 |      |                                     |      |  |     |      |     |  |     |      |     |
| 40U          |                                                                                                                                                                                                                                                                                                                                                                                                                                                                                                                                                                                                                                                                                                                                                                                                                                                                                                                                                                                                                                                                                                                                                                                                                                                                                                                                                                                                                                                                                                                               | 50UW |                                          | 40W  |                                     |              |              |                |  |  |  |  |  |    |                          |     |                                          |      |                                     |  |     |      |      |  |     |                 |      |                                     |      |  |     |      |     |  |     |      |     |

|   |                 |  |     |   |  |   |
|---|-----------------|--|-----|---|--|---|
| 5 | PACKING<br>パッキン |  | NBR | 2 |  | ◎ |
|---|-----------------|--|-----|---|--|---|



|   |                         |  |             |   |  |                |
|---|-------------------------|--|-------------|---|--|----------------|
| 7 | SEAL WASHER<br>シールワッシャー |  | SPCC<br>NBR | 4 |  | WF-12<br><br>◎ |
|---|-------------------------|--|-------------|---|--|----------------|

|    |                |  |     |   |  |                                 |
|----|----------------|--|-----|---|--|---------------------------------|
| 10 | O-RING<br>Oリング |  | NBR | 1 |  | JIS B2401, 1A<br>G-240<br><br>◎ |
|----|----------------|--|-----|---|--|---------------------------------|

|    |                |  |     |   |  |                                 |
|----|----------------|--|-----|---|--|---------------------------------|
| 11 | O-RING<br>Oリング |  | NBR | 1 |  | JIS B2401, 1A<br>P-375<br><br>◎ |
|----|----------------|--|-----|---|--|---------------------------------|

|                         |  |                                                                                                                      |                     |                      |                         |                               |
|-------------------------|--|----------------------------------------------------------------------------------------------------------------------|---------------------|----------------------|-------------------------|-------------------------------|
| SPARE PARTS LIST/予備品リスト |  | APPROVED BY/審<br>Y. ICHIRAKU                                                                                         | CHECKED BY/検<br>--- | DESIGNED BY/設<br>--- | DRAWN BY/描<br>T. YAMADA | DATE DRAWN/日<br>JAN. 05. 2005 |
| MODEL CODE/型式<br>TL-200 |  |  <b>TAISEIKOGYO<br/>CO., LTD.</b> |                     |                      |                         |                               |

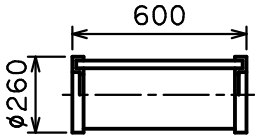
| PART NO.<br>部品番号 | PARTICULARS<br>部品名称 | SKETCH<br>概略図 | MATERIAL<br>材質 | QUANTITY<br>(FOR 1 UNIT)<br>数量 (1台分) |             | REMARKS<br>備考<br>FOR ELEMENT REPLACEMENT<br>◎: エLEMENT交換用 |
|------------------|---------------------|---------------|----------------|--------------------------------------|-------------|-----------------------------------------------------------|
|                  |                     |               |                | WORKING<br>常備                        | SPARE<br>予備 |                                                           |

|   |                  |                                                                                   |                     |   |  |                                                                                                      |
|---|------------------|-----------------------------------------------------------------------------------|---------------------|---|--|------------------------------------------------------------------------------------------------------|
| 4 | ELEMENT<br>エレメント |  | ANOTHER TABLE<br>別表 | 1 |  | P-TL-200<br><br>◎ |
|---|------------------|-----------------------------------------------------------------------------------|---------------------|---|--|------------------------------------------------------------------------------------------------------|

| SYMBOL<br>記号 | MATERIAL<br>材質       |  |      |                                |      |                                  |
|--------------|----------------------|--|------|--------------------------------|------|----------------------------------|
| 8C           | FIBER SECC           |  | 5UW  | SUS304                         | 200W | SUS SECC<br>(WIRE GAUZE)<br>(金網) |
| 25C          | ( $\beta \geq 200$ ) |  | 10UW | SUS316<br>(WIRE GAUZE)<br>(金網) | 150W |                                  |
| 10U          |                      |  | 20UW |                                | 100W |                                  |
| 20U          | PAPER/紙<br>SECC      |  | 40UW | SUS SECC                       | 60W  |                                  |
| 40U          |                      |  | 50UW | (WIRE GAUZE)<br>(金網)           | 40W  |                                  |
|              |                      |  |      |                                |      |                                  |

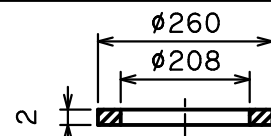
|   |                 |                                                                                   |     |   |  |   |
|---|-----------------|-----------------------------------------------------------------------------------|-----|---|--|---|
| 5 | PACKING<br>パッキン |  | NBR | 2 |  | ◎ |
|---|-----------------|-----------------------------------------------------------------------------------|-----|---|--|---|

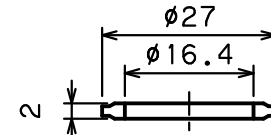
|   |                         |                                                                                    |             |   |  |            |
|---|-------------------------|------------------------------------------------------------------------------------|-------------|---|--|------------|
| 7 | SEAL WASHER<br>シールワッシャー |  | SPCC<br>NBR | 4 |  | WF-16<br>◎ |
|---|-------------------------|------------------------------------------------------------------------------------|-------------|---|--|------------|

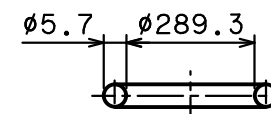
|    |                     |                                                                                     |     |   |  |                             |
|----|---------------------|-------------------------------------------------------------------------------------|-----|---|--|-----------------------------|
| 10 | 〃 O RING<br>〃 O リング |  | NBR | 1 |  | JIS B2401, 1A<br>G-290<br>◎ |
|----|---------------------|-------------------------------------------------------------------------------------|-----|---|--|-----------------------------|

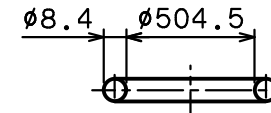
|    |                     |                                                                                     |     |   |  |                             |
|----|---------------------|-------------------------------------------------------------------------------------|-----|---|--|-----------------------------|
| 11 | 〃 O RING<br>〃 O リング |  | NBR | 1 |  | JIS B2401, 1A<br>P-505<br>◎ |
|----|---------------------|-------------------------------------------------------------------------------------|-----|---|--|-----------------------------|